

ecostrad

INSTRUCTION MANUAL

Ecostrad Designer Electric Radiators

ALLERTON
Horizontal

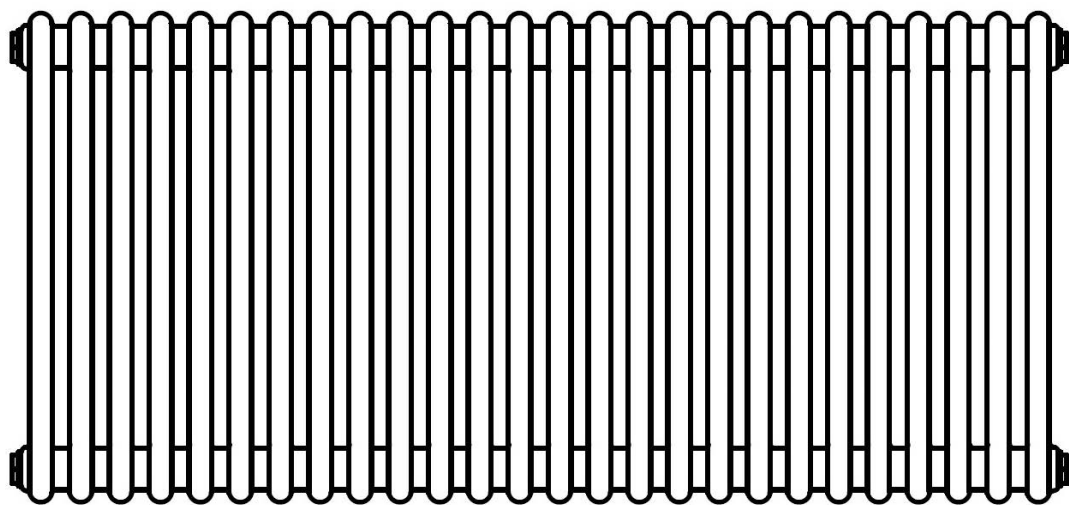

PLEASE READ AND SAVE THESE INSTRUCTIONS



Symbols



Warning

This symbol indicates a hazard with an average risk level which, if not avoided, could result in serious injury or death.



Warning of electrical voltage

This symbol indicates danger to the life and health of persons due to electrical voltage.



Hot surface

This symbol located on the device indicates that its surfaces are hot during and immediately after operation. Hot surfaces should not be touched: danger of burns.



Do not cover

This symbol indicates that it is prohibited to hang objects (such as towels, clothes etc.) on the device such that the electric components could become covered. To avoid overheating and fire hazards, ensure the electric components are never covered.



Observe instructions in manual

This symbol located on the device indicates that instructions in the operating manual must be observed when installing and using the device.

Contents

1	About the Product	4
2	Warnings & Precautions	5
3	Installation	7
3-1	Components	7
3-2	Fitting the element	8
3-3	Wall mounting	8
3-4	Connecting the element	10
3-5	Bleeding the radiator	10
4	Using Your Ecostrad Radiator	11
4-1	First use	11
4-2	General usage	11
5	Cleaning & Maintenance	12
6	Troubleshooting	13
7	Warranty	15
8	ErP Ecodesign Information	16
9	Disposal	17

1 | About the Product

This manual describes the **Ecostrad Allerton Designer Radiator** and details how to install and use the product. It is important to thoroughly review this manual before using the product.

For **technical advice** or help concerning the Ecostrad Allerton Designer Radiator, contact the retail establishment or distributor from which the product was purchased.

Heat Performance

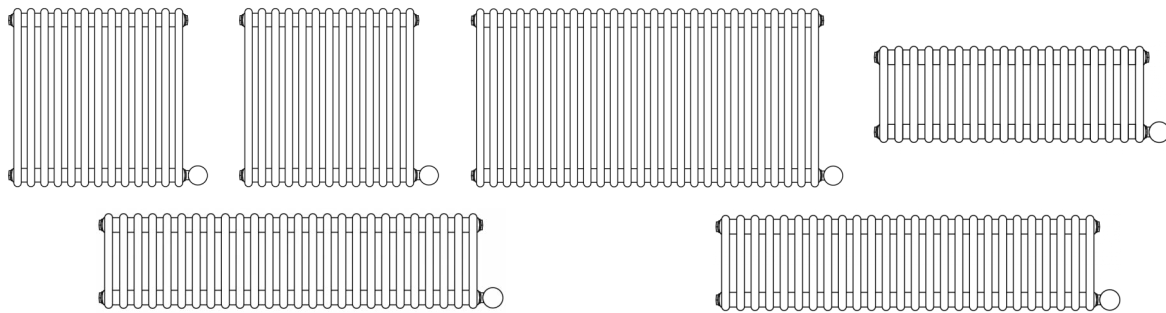

The Ecostrad Allerton is a thermal-fluid filled radiator designed to be fitted with the Ecostrad iQ WiFi Heating Element. This heating element, when inserted into the Ecostrad Allerton, will heat to set programs and control the room temperature to ensure you are always warm when you want to be.

To do this, the heating element heats the thermal fluid in the radiator. This heated liquid rises through the unit, forcing colder liquid towards the element and setting off a convection cycle. This process of rising and falling liquid spreads heat throughout the radiator.

Each size of Ecostrad Allerton is a self-contained unit with its own, unique, thermal “ecosystem” dictated by the behaviour of these natural convection currents. This means you can expect more variance between sizes of designer electric radiators than you would find in central heating systems, where the radiators are merely vessels in one, larger, pressurised system.

For more information about how designer electric radiators work, and how to get the best out of your electric heating system, see section **4-2**.

Quality

Here at Ecostrad, we pride ourselves on our strict quality control to ensure only the best products arrive at your home. However, the Ecostrad Allerton is constructed using some manual processes, and this human touch means each radiator is unique. Some idiosyncrasies in finish can be expected. These differences should not impair the heating performance, durability, or visual impact of your Ecostrad Allerton.

2 | Warnings & Precautions

Read all safety warnings and all instructions in this manual carefully before using or installing the radiator. Failure to follow the warnings and instructions may result in electric shock, fire, serious injury, or all of the above. Save all warnings and instructions for future reference.

Check that all ancillary components are present and that the product has not suffered any damage during transit.



NOTE - This radiator is supplied with an electric heating element and is for use with an electric supply only. The product cannot be used as part of a central heating system or as a dual source radiator. This radiator has been pre-filled and adjusted for electric use. No filling is required. Do not remove any of the seals as this might cause leakages and void the warranty. Improper adjustment of the fluid level in the radiator can cause malfunction.

The radiator can be used for heating throughout the home provided it is fitted with and controlled via the supplied heating element. Consult the manual of the supplied element for full safety, installation and functionality details.



Warning

This appliance is not intended for use by persons (including children) with reduced physical, sensory or mental capabilities, or lack of experience or knowledge, unless they have been given supervision or instruction concerning use of the appliance by a person responsible for their safety. Children should be supervised to ensure they do not play with the appliance.



Warning

This appliance can be used by children aged from 8 years and above and persons with reduced physical, sensory or mental capabilities or lack of experience and knowledge if they have been given supervision or instruction concerning use of the appliance in a safe way and understand the hazards involved. Children shall not play with the appliance. Cleaning and user maintenance shall not be made by children without supervision.



Warning

As with conventional radiators, this electric radiator will get hot to the touch during operation. If the radiator is left on full power for a prolonged period of time the surface temperature can rise to 70 °C (+/- 5 °C). Particular attention should be given where children and vulnerable adults are present.





Warning

When drilling or fixing into walls, floors or ceilings it is essential you check for pipes and wires before commencing. Please ensure that you wear all necessary personal protective equipment.

- The device must not be located immediately below an electrical socket outlet.

The electronic components of the product must not be covered. Covering the heater such that the electronic components would be covered may cause the unit to overheat. If there is any risk that the electronic components could become covered, do not cover the radiator.







3 | Installation

3-1 | Components

Before beginning installation, check that all fixings in **Table 1** are supplied. The radiator should only be mounted with the manufacturer's fixings.

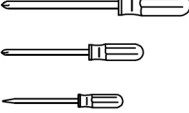
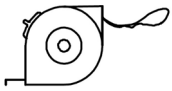
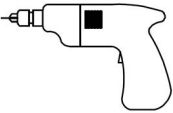



Table 1 | Fixings and components

Part	Description		Quantity
A	Brackets		5
B	Wall Plugs		10
C	Wall Screws		10
D	Element*		1

*The heating element is packaged separately from the radiator and may arrive in a separate delivery.

The tools you will require for this installation are listed below. **Please note that these materials are not supplied with the radiator.**

Table 2 | Tools Required

Tool			
Adjustable Wrench		Screwdrivers	
Tape Measure		Electric Drill	
Spirit Level		10mm drill bit	
PTFE Tape		Pencil	

3-2 | Fitting the element

Full instructions for fitting the element can be found within the element manual. The user must ensure installation is in accordance with the following:

- The element must be fitted at the bottom of the radiator on the side. It may be fitted on the left or right side.
- The heating element must not be connected to the electric supply until it is secured inside the radiator and correctly orientated.
- The radiator is filled with an anti-freezing liquid exactly to the level required by the element. Ensure that no liquid is lost during installation.
- Do not hang the radiator with the heating element at the top (**Figure 1**).

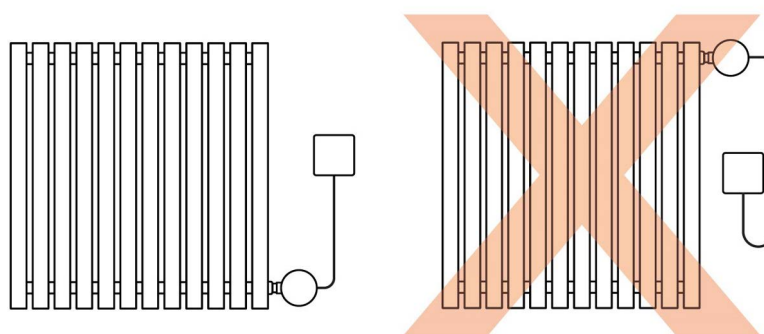

Figure 1 | Correct and incorrect element positioning

3-3 | Wall mounting

1. Check that the wall is strong enough to hold the weight of the pre-filled radiator. The fixings supplied are suitable for use in solid masonry. For any other wall type you will need to source appropriate fixings. If fitting to a plasterboard wall, either fit directly to the wooden struts or otherwise strengthen the wall; do not fix through plasterboard alone. Additional Brackets are available on request.
2. Use the mounting template printed onto the box to measure the positions for the Brackets.

Alternatively, if you are fitting the radiator to a stud wall and struggling to line the Bracket positions up with the studs, it may be useful to choose a custom mounting position.

- a. Choose a distance between the Brackets **(A)** that corresponds with your specifications.
 - b. Check that the Brackets **(A)** slot between the radiator bars correctly. Adjust Bracket distances if necessary.
 - c. Use a tape measure, spirit level and positions decided in **a.** and **b.** to mark the custom drilling positions on the wall.
3. Drill the ten required holes in the wall using a 10mm drill bit and push the Wall Plugs **(B)** inside.
 4. Position the Brackets **(A)** over the holes and fix in place with the Wall Screws **(C)**.

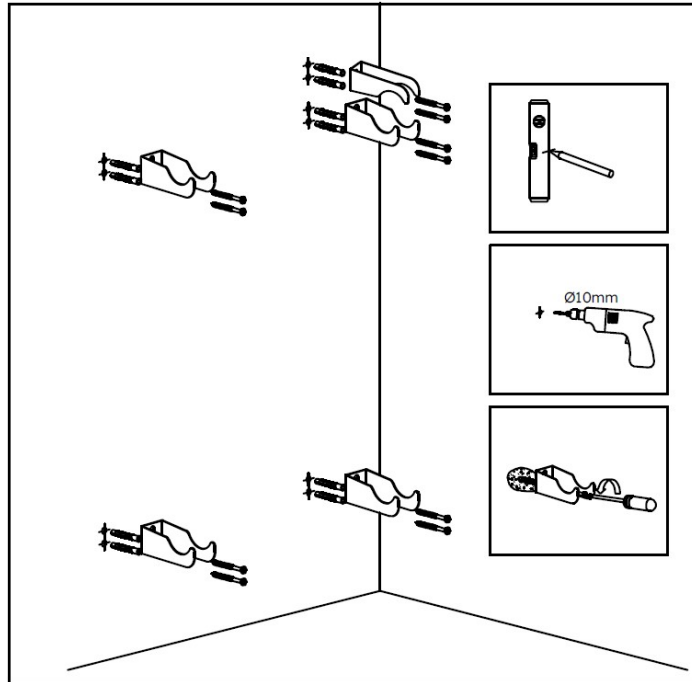

Figure 2 | Fixing the radiator Brackets

5. The radiator is now ready to mount. You may choose to add the optional security Bracket at this stage, see **Figure 3**.

a. Lift the radiator onto the Brackets.

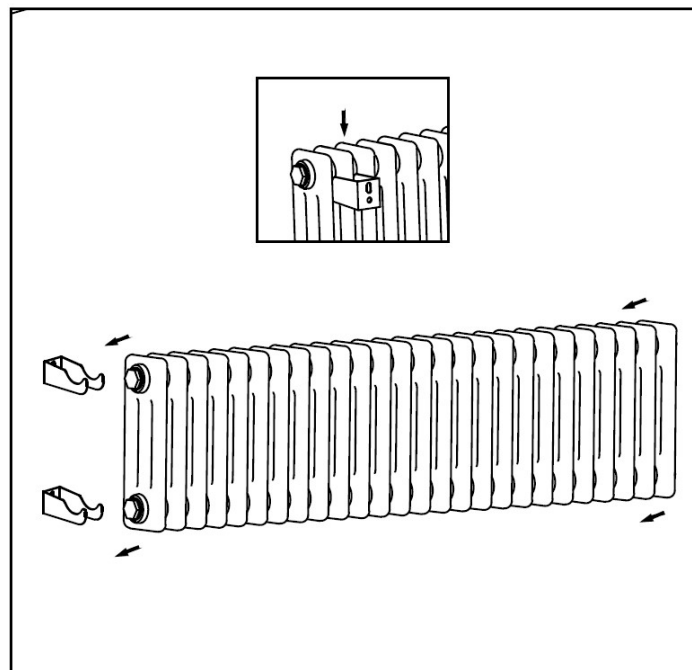



Figure 3 | Fixing the radiator Brackets

b. **OPTIONAL** – Position the remaining Bracket pointing downwards above one of the top Brackets, such that the radiator top bar is now locked in place. Mark the Bracket location on the wall before lifting the radiator off the Brackets.

- c. Use the 10mm drill bit to drill the marked Bracket hole and push the remaining Wall Plugs (B) inside. Replace the radiator, re-position the Bracket (A) and use the remaining Wall Screws (C) to fix.

3-4 | Connecting the element

Wiring the heating element to the mains is a job for a qualified electrician. Please consult the element manual for full instructions and safety warnings, paying special consideration to the following:

- The radiator and its element are designed to be used under AC 230 voltage and should be connected to the household fixed wiring by a qualified electrician in accordance with national wiring regulations. Risk of electric shock. 
- Do not install the radiator under or in front of a power socket or connector box.
- The power lead must be connected to a socket which must be at least 25cm from the floor. Do not connect the element to the power supply until it is secured within the radiator and correctly orientated, as demonstrated in **Figure 1**.

3-5 | Bleeding the radiator

For best results, it is recommended to bleed the radiator after 30 minutes of heating.

To do this:

1. Check that you have installed the radiator so that the bleeding valve is at the top of the radiator.
2. Insert a screwdriver into the valve and unscrew it.
3. When liquid begins to come out of the valve, screw it closed again.

Use a cloth or a container to catch and dispose of any leaking liquid.

4 | Using Your Ecostrad Radiator

4-1 | First use

Once your radiator is installed and the element connected to the power by a qualified electrician, it is ready to heat your home.

Banging or creaking noises are not unusual during the first heating phase of the radiator. This is because the steel can become very cold during transit, and when heat is introduced to cold metal, the metal expands quickly, causing expansion noises. This may persist for the first few days of heating as the product acclimatises to your home.

Bleeding

After the first 30 minutes of heating, it is recommended to bleed the radiator. To do this:

1. Check that you have installed the radiator so that the bleeding valve is at the top of the radiator.
2. Insert a screwdriver into the valve and unscrew it.
3. When liquid begins to come out of the valve, screw it closed again.

Use a cloth or a container to catch and dispose of any leaking liquid.

4-2 | General usage

Designer Electric Radiators marry together the sleek aesthetics and pleasant heating of modern central heating radiators with the controllability of electric.

However, although the room heating performance of a designer electric radiator is similar to that of a central heating radiator, the movement of heat across the units themselves can feel a little different. That is because each radiator in a central heating system is simply a vessel in one pressurised system: heated water is pushed through the radiator, ensuring an even surface temperature.

For designer electric radiators, which are self-contained, surface temperatures take longer to even out; the flow of hot liquid depends on internal convection currents spreading heated liquid across the unit.

The “dynamic” nature of these products means the heat up behaviour is less consistent than what you may have experienced with other, static electric heaters. However, this is perfectly normal, and allows you to enjoy the benefits of electric heating as well as the varied designs of steel, fluid-filled radiators.

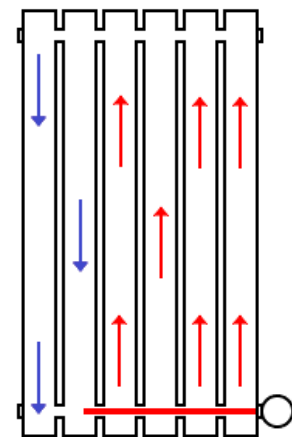

Figure 4 | Depiction of heat in an Ecostrad Allerton (stylised)

4-2-1 | Getting the best out of your Ecostrad Allerton

For best results:

- **Allow a few days of heating regularly and gently** when first installed to calibrate the radiator to your home and to ensure the product is heating correctly. At first, the lower bars or those furthest from the heating element may feel cooler than the rest of the radiator: this is expected behaviour. The heat distribution should become more even over time. However, because of the dynamic nature of convection, there will always be some discrepancy between the top and bottom of the radiator.
- **Set a program on the heating element** (see the heating element's manual for details) as Ecostrad Designer Electric Radiators work best when maintaining consistent temperatures.
- **Always allow enough time for the radiator to heat the walls and air** before the warmth is needed, especially when the radiator is heating a colder room. This is recommended because designer electric radiators, like central heating radiators, heat the air through convection and the solid objects of a room through gentle radiated heat. Whilst convection is fast, radiated heat is absorbed into the walls, floors and furniture, which takes longer. Allowing enough time for the radiator to heat the room with radiated heat results in a more deeply warmed room, ensuring it holds heat for longer when the radiator is turned down or off.
- **Do not allow the room to cool significantly between heating periods.** This forces the radiator to heat more aggressively, which could result in uneven heat distribution.

If you have concerns about the heat performance of your radiator, contact the retail establishment or distributor from which the product was purchased

4-2-2 | Covering your radiator

Unlike most electric heating products, the Ecostrad Allerton is just like typical central heating radiators in that it can be used to dry clothing or towels. However, please be aware that covering your radiator will reduce its useful heating output for the room.

You must NEVER cover the electrical heating element – doing so risks overheating the electrical components which could result in irreparable damage or fire. **Covering the heating element will void the product's warranty.**



5 | Cleaning & Maintenance

Regular cleaning with a soft, damp cloth will keep the surface of your product looking new. Do not use abrasive or chemical cleaners as these will damage the finish over time.

Always ensure the heating element is disconnected from the power before attempting any maintenance or cleaning. Risk of electric shock.



6 | Troubleshooting

For common issues, see the table below. For control issues, see the manual of the heating element.

If you have any other concerns, contact the retail establishment or distributor from which the product was purchased.

Issue	Explanation/Solution
Radiator is making noise	<p>1) Banging noises may occur as the metal expands. This can happen at any time, particularly when the metal is heated from cold, but it is more common after first installation. Follow the usage guidelines in section 4-2 to minimise expansion noises. If the issue persists or is accompanied by other issues, contact your retailer.</p>
Radiator is cool to the touch	<p>1) Check the set temperature. If the set temperature is lower than the room temperature, the radiator will not heat.</p> <p>2) If the set temperature is higher than the room temperature, check that the heating element is calling for heat by checking for the heating symbol. If there is no heating symbol, this may indicate an element issue, such as incorrect temperature compensation, Open Window Detection being triggered, incorrect mode, or an electronic fault. Check the element manual for details on how to correct these issues.</p> <p>3) Check how long the product has been heating. Radiators that have been heating continuously for less than 45 minutes may not be at their maximum temperature.</p> <p>4) Check the ambient room temperature. In cold rooms the product may feel colder to the touch as the heat produced is quickly transferred to the room. This is particularly likely in cases where there is an extreme difference in temperature between the radiator and the room. See section 4-2 for usage guidelines.</p>

Issue	Explanation/Solution
<p>The surface of the radiator has faults/is no longer perfect</p>	<p>Please see the warranty section of this manual (section 7) for details of what is and is not covered by the warranty. Note that regular cleaning of your radiator (as stated in section 5) will help keep the surface of your radiator looking new.</p>
<p>Radiator is hotter on one side than the other</p>	<p>Uneven surface temperature on an Electric Designer Radiator is perfectly normal, particularly during the initial heat up time. These radiators are powered by an electric element which heats the liquid in the bottom half of the radiator. The liquid circulates due to convection alone: it is not pushed by any fan or propeller, and so takes time to circulate fully. Always allow your radiator to heat for a few hours before testing to see if surface temperature is uneven. Uneven surface temperature is also more common when trying to heat a cold room quickly - see section 4-2.</p>
<p>Radiator is hotter to the touch when covered with a towel</p>	<p>Radiators covered by a towel or clothes may heat up quicker or feel hotter to the touch than those that are not covered. This is because the fabric traps the heat in the radiator, meaning the surface temperature raises more quickly and to higher extremes. However, this means less heat is being transferred to the room. To heat a room most effectively, do not cover your radiator. NEVER cover the electrical heating element. Risk of fire.</p>

7 | Warranty

The Ecostrad Allerton Designer Radiator carries a 10-year guarantee on the steel body, a 3-year guarantee on paintwork and a 2-year guarantee on electrical components.

What does the warranty cover?

Within the stated period, starting from the date the customer receives their unit, Ecostrad guarantee to repair or replace the unit where a fault is due to defects in materials or manufacturing.

What does the warranty NOT cover?

The warranty does not cover any defect arising from damage, negligence, usage outside the product's intended purpose or fair wear and tear. The warranty is only valid when the radiator has been used with the supplied heating element, at the specified supply voltage, and in accordance with all conditions specified in this manual. The warranty will be void if the radiator has been tampered with, if its fluid levels have been adjusted, or if the ratings label has been removed.

The warranty does not cover failures and faults due to force majeure, accidental damage, mishandling, external impact, chemical agents or atmospheric phenomena, incorrect use of the unit, the purchaser's faulty electrical installations, transporting the unit or problems caused by the unit being handled by persons not authorised by Ecostrad. An invoice may be required to confirm that installation work has been carried out by a qualified professional. Ecostrad cannot accept responsibility for damage, loss or injury caused by incorrect installation, maintenance, cleaning or covering the unit.

The warranty does not cover any minor defect in finish on the back or the brackets of the product, which do not impair the structural integrity or overall look of the product.

How to claim

The warranty is a contract with the original purchaser and does not transfer if the unit is re-sold, gifted or inherited. Proof of purchase, including order number and order confirmation or invoice, will be required if a claim is made. The warranty covers only the model of heater shown on the purchase invoice. The warranty covers the repair or replacement of the defective product only and Ecostrad shall have no liability for installation costs or consequential losses however incurred. Claims must be made with the establishment where the unit was purchased. This warranty does not affect the customer's consumer rights.

8 | ErP Ecodesign Information

Table 3 | Output guidelines

Model	600W	1000W	1200W	1500W
Heat output				
Nominal heat output (P_{nom} /kW)	0.6	1.0	1.2	1.5
Minimum heat output (indicative) (P_{min} /kW)	0.6	1.0	1.2	1.5
Maximum continuous heat output ($P_{max,c}$ /kW)	0.6	1.0	1.2	1.5
Auxiliary electricity consumption				
At nominal heat output (el_{max} /kW)	N/A	N/A	N/A	N/A
At minimal heat output (el_{min} /kW)	N/A	N/A	N/A	N/A
In standby mode (el_{sb} /kW)	0.0006	0.0006	0.0006	0.0006

Table 4 | Information requirements for electrical space heaters

Item	Unit
Type of heat input, for electric storage local space heaters only (select one)	
manual heat charge control, with integrated thermostat	N/A
manual heat charge control with room and/or outdoor temperature feedback	N/A
electronic heat charge control with room and/or outdoor temperature feedback	N/A
fan assisted heat output	N/A
Type of heat output/room temperature control (select one)	
single stage heat output and no room temperature control	[no]

Table 4 | Information requirements for electrical space heaters

Item	Unit
Two or more manual stages, no room temperature control	[no]
with mechanic thermostat room temperature control	[no]
with electronic room temperature control	[no]
electronic room temperature control plus day timer	[no]
electronic room temperature control plus week timer	[yes]
Other control options (multiple selections possible)	
room temperature control, with presence detection	[no]
room temperature control, with open window detection	[yes]
with distance control option	[yes]
with adaptive start control	[no]
with working time limitation	[yes]
with black bulb sensor	[no]

9 | Disposal



In accordance with WEEE Directive 2012/19/EU, the icon with the crossed-out waste bin on electrical or electronic equipment stipulates that this equipment must not be disposed of with household waste at the end of its life. You will find collection points for free return of waste electrical and electronic equipment in your vicinity. The addresses can be obtained from your local authority.

The separate collection of waste electrical and electronic equipment enables the re-use, recycling and other forms of recovery of waste equipment, and prevents any negative effects for the environment or human health caused by the disposal of hazardous substances potentially contained in the equipment.

For queries, contact:

In the UK

Ecostrad Ltd.
 Firecrest House
 Lingerfield Business Park
 Market Flat Lane
 Knaresborough
 North Yorkshire
 HG5 9JA

In ROI

Ignition Heatco Ireland Limited
 Unit 282
 Block G
 Blanchardstown Corporate Park 2
 Dublin
 Republic of Ireland
 D15 R65X

<https://ecostrad.com/>